

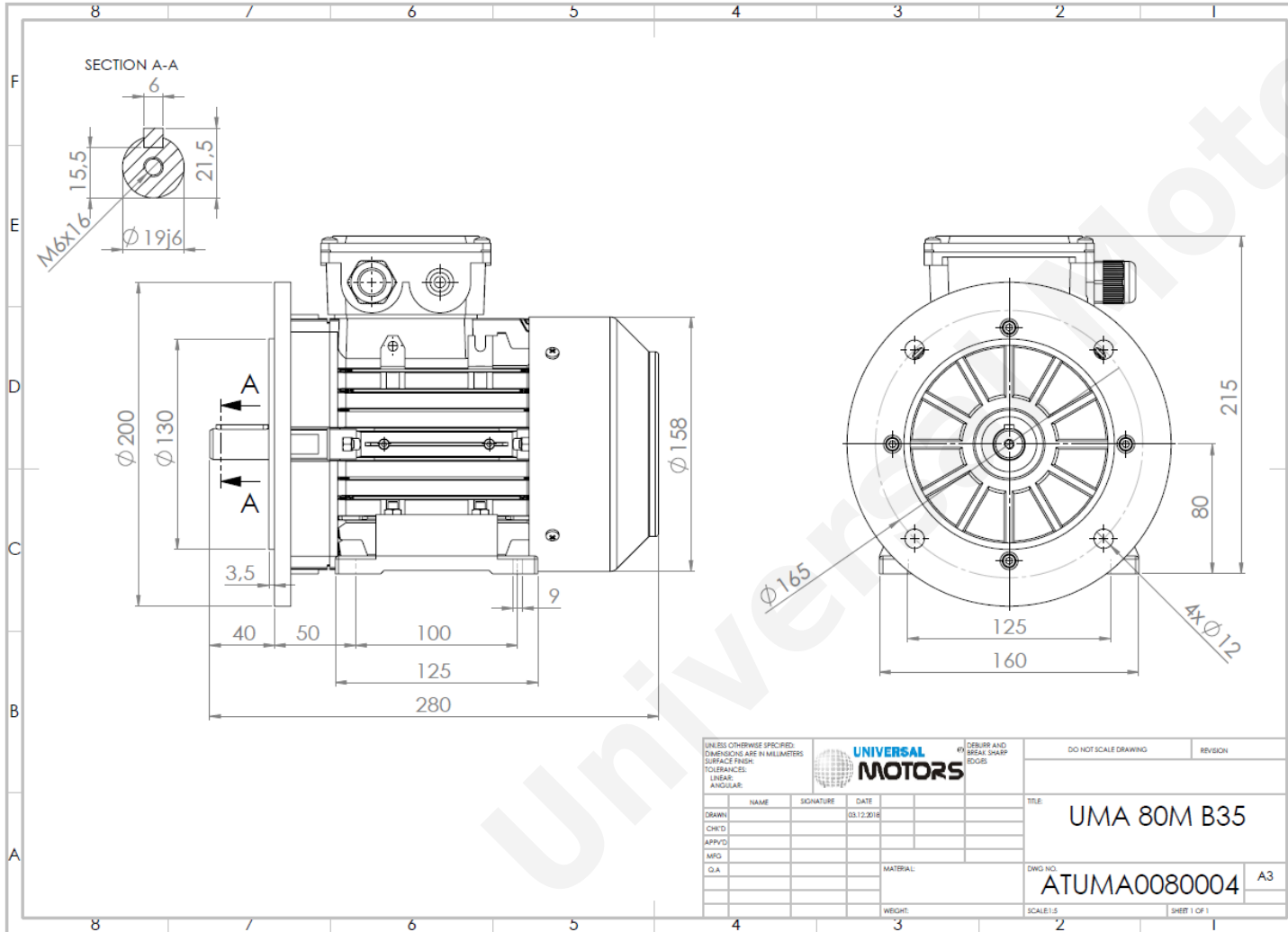

TECHNICAL DATA

Three Phase Electric Motors - Aluminum Frame
 UM3A 80M3-6 IE3
 0.75 kW / 1 Cv
 935 RPM



Motor type:	UM3A 80M3-6 IE3
Output:	0.75 kW / 1 Cv
Speed (min ⁻¹):	935 RPM
Frequency:	50 Hz
Voltage:	400 V
Current:	2.18 A
Power factor (Cos Ø):	0.63
Poles:	6
Insulation class:	F
Temperature rise Class:	B
Efficiency 50%:	74.4 %
Efficiency 75%:	78.2 %
Efficiency 100%:	78.9 %
Torque:	7.7 N.m
Tstarting/Tnominal:	2.8
Istarting/Inominal:	4.9
Tmaximum/Tnominal:	3.1
Noise:	59 Db(A)
Weight:	12.5 Kg
Brake AC:	AC3
Torque Brake DC:	8 N.m
Bearing DE:	6204 2Z
Bearing NDE:	6204 2Z
Torque Brake AC:	15 N.m
Brake DC:	REB-05-08

Regime - S1

Altitude - 1000m

Environment Temperature - 40°C

CONTACTS:

UNIVERSAL MOTORS Tel: +351 252 299 080
 Rua de São Brás,745 Fax: +351 252 299 089
 4480-782 VILA DO CONDE Mail: geral@universalmotors.pt

* References applied only in the UK